



XW-MTB-01



XW-MTB-02



XW-MTB-03



XW-MTB-04



XW-MTB-05



XW-MTB-06



XW-MTB-07



XW-MTB-08



XW-MTB-09



XW-MTB-10



XW-MTB-11



XW-MTB-12



XW-MTB-13



XW-MTB-14



XW-MTB-15



XW-MTB-16



XW-MTB-17



XW-MTB-18



XW-MTB-19



XW-MTB-20



XW-MTB-21



XW-MTB-22



XW-MTB-23



XW-MTB-24



XW-MTB-25



XW-MTB-26



XW-MTB-27



XW-MTB-28



XW-MTB-29



XW-MTB-30



XW-MTB-31



XW-MTB-32



XW-MTB-33



XW-MTB-34



XW-MTB-35



XW-MTB-36



XW-MTB-37



XW-MTB-38



XW-MTB-39



XW-MTB-40







XW-BMX-08



XW-BMX-09



XW-BMX-10



XW-BMX-11



XW-BMX-12



XW-BMX-13



XW-BMX-14



XW-BMX-15



XW-HB-01



XW-HB-02



XW-HB-03



XW-HB-04



XW-HB-05



XW-HB-06



XW-HB-07



XW-HB-08





XW-PD-01



XW-PD-02



XW-PD-03



XW-PD-04



XW-PD-05



XW-PD-06



XW-PD-07



XW-PD-08



XW-PD-09



XW-PD-10



XW-PD-11



XW-PD-12



XW-PD-13



XW-PD-14



XW-PD-15



XW-PD-16



XW-PD-17



XW-PD-18



XW-PD-19



XW-PD-20



XW-PD-21



XW-PD-22



XW-PD-23



XW-PD-24



XW-PD-25



XW-PD-26



XW-PD-27



XW-PD-28



XW-PD-29



XW-PD-30



XW-PD-31



XW-PD-32



XW-PD-33



XW-PD-34



XW-PD-35



XW-PD-36



XW-PD-37



XW-PD-38



XW-PD-39



XW-PD-40



XW-PD-41



XW-PD-42



XW-PD-43



XW-PD-44



XW-PD-45



XW-PD-46



XW-PD-47



XW-PD-48



XW-PD-49



XW-PD-50



XW-PD-51



XW-PD-52



XW-PD-53



XW-PD-54



XW-PD-55



XW-PD-56



XW-PD-57



XW-PD-58



XW-PD-59



XW-PD-60



XW-PD-61



XW-PD-62



XW-PD-63



XW-PD-64



XW-PD-65



XW-PD-66



XW-PD-67



XW-PD-68



XW-PD-69



XW-PD-70



XW-PD-71



XW-PD-72



XW-PDA-1



XW-PDA-2





XW-HDB-01

Material: Steel
Diameter: 22.2
Back Swept:
Width 480mm



XW-HDB-02

Material: Steel
Width: 560/580/600mm
Raise: 70mm
Colour: To Order



XW-HDB-03

Material: Steel
Width: 480-560mm
Raise: 30mm
Colour: To Order



XW-HDB-04

Material: Steel
Width: 560/580/600mm
Colour: To Order



XW-HDB-05

Material: Steel
Width: 520mm
Raise: 80mm
Colour: To Order



XW-HDB-06

Material: Steel
Width: 520/600mm
Raise: 100/120mm
Colour: To Order



XW-HDB-07

Material: Steel
Width: 560/620mm
Raise: 170/210mm
Colour: To Order



XW-HDB-08

Material: Steel
Width: 560/620mm
Raise: 60mm
Colour: To Order



XW-HDB-09

Material: Steel
Width: 580/680mm
Raise: 200mm
Colour: To Order



XW-HDB-10

Material: Steel
Width: 480/560mm
Raise: 120/150mm
Colour: To Order



XW-HDB-11

Material: Steel
Width: 580/700mm
Raise: 200mm
Colour: To Order



XW-HDB-12

Material: Steel/Alloy
Width: 480-560mm
Raise: 120/150mm
Colour: To Order



XW-HDB-13

Material: Steel
Width: 600/620/640mm
Raise: 80mm
Colour: To Order



XW-HDB-14

Material: Steel
Width: 680mm
Raise: 200mm
Colour: To Order



XW-HDB-15

Material: Steel
Width: 600/640mm
Raise: 150mm
Colour: To Order



XW-HDB-16

Material: Alloy 6061+T6
Size: 22.2*25.4/31.8*580~600mm



XW-HDB-17

Material: Steel
Width: 520/590mm
Raise: 70mm
Colour: To Order



XW-HDB-18

Material: Steel
Width: 380~430mm
Raise: 135mm
Colour: To Order



XW-HDB-19

Material: Alloy 6061+T6
Size: 22.2*25.4*420~520mm



XW-HDB-20

Material: Alloy 6061+T6
Size: 22.2*25.4*520~680mm



XW-HDB-21

Material: Alloy 6061+T6
Size: 22.2*25.4*520~680mm





XW-HDS-01

Material: steel
Extension: 30mm
Length: 150/240mm
Diameter: 22.2
Colour: To Order



XW-HDS-02

Material: steel
Extension: 40/60/80mm
Length: 150/300mm
Diameter: 22.2/25.4
Colour: To Order



XW-HDS-03

Material: steel
Extension: 35mm
Length: 150mm
Diameter: 22.2
Colour: To Order



XW-HDS-04

Material: steel/Alloy top
EXT:40mm
LENGTH:150mm



XW-HDS-05

Material: Steel
Extension: 60-120mm
Riast: 10° -45°
Length: 150-200mm



XW-HDS-06

Material: Steel
Extension: 60-120mm
Riast: 10° -45°
Length: 150-200mm



XW-HDS-07

Material: Steel
Extension: 60-120mm
Riast: 10° -45°
Length: 150-200mm



XW-HDS-08

Material: Steel
Extension: 60-120mm
Riast: 10° -45°
Length: 150-200mm



XW-HDS-09

Material: Steel
Extension: 60-120mm
Riast: 10° -45°
Length: 150-200mm



XW-HDS-10

Material: Steel
Extension: 60-120mm
Riast: 10° -45°
Length: 28.6*22.2*
150-200mm



XW-HDS-11

Material: steel/Alloy
Extension: 45mm
Length: 180/210mm
Diameter: 22.2/25.4
Colour: To Order



XW-HDS-12

Material: Steel/Alloy
Length: 150mm



XW-HDS-13

Material: Steel/Alloy
Ext: 40mm
Length: 145mm
Finish: CP/ED/PINTIN
Diameter: 21.1/22.2



XW-HDS-14

Material: Alloy
Extension: 45mm
Length: 150mm
Diameter: 21.1/22.2
Colour: To Order



XW-HDS-15

Material: Alloy
Extension: 50mm
Colour: To Order



XW-HDS-16

Material: Alloy
Ext: 80mm
Riast: 10°
Length: 150mm



XW-HDS-17

Material: steel
Extension: 70/80/90/100mm
Length: 50mm
Riast: 15°



XW-HDS-18

Material: steel
Extension: 60/80/100mm
Length: 42mm
Riast: 15°
Colour: To Order



XW-HDS-19

Material: Alloy
Extension: 80/100mm
Length: 42mm
Riast: 7°
Colour: To Order



XW-HDS-20

Material: Alloy6061+T6
Size: 31.8*28.6*90mm



XW-HDS-21

Material: Alloy6061+T6
Size: 28.6*25.4*135/150mm
28.6*22.2*135/150mm
28.6*25.4*135/150mm
25.4*21.1*135/150mm



XW-HDS-22

Material: Alloy6061+T6
Size: 22.2(21.1/25.4)
*25.4*150*95mm



XW-HDS-23

Material: steel
Length: 28.6*22.2*150mm



XW-HBE-01

Material: Alloy
Diameter: 22.2
Length: 125mm
Forward Swept: 18°
Allen Bolt
Finish: SILVER/COLOR



XW-HBE-02

Material: Steel
Length: 150/170mm
Colour: To Order



XW-HBE-03

Material: ALLOY
Diameter: 22.2
Length: 80mm
Forward Swept:
Allen Bolt:
Finish: SILVER/COLOR



XW-HBM-01

Material: Steel
Diameter: M8*165
Colour: To Order



XW-HBM-02

Material: Steel
Diameter: M8*165/420
Colour: To Order



XW-HBM-03

Material: Steel
Diameter: M8*10
Colour: To Order



XW-HBM-04

Material: Steel
Diameter: M10*160
Colour: To Order



XW-SP-01

Material: Steel
Diameter: 22.2*28.6
Length: 150/180/200/220/250/
280/300/400/450mm
Finish: CP/ED/SF/AL/COLOR



XW-SP-02

Material: Steel
Diameter: 22.2*27.2
Length: 150/180/200/220/250/
280/300/400/450mm
Finish: CP/ED/SF/AL/COLOR



XW-SP-03

Material: Steel
Diameter: 22.2*25.4
Length: 150/180/200/220/250/
280/300/400/450mm
Finish: CP/ED/SF/AL/COLOR



XW-SP-04

Material: Steel
Diameter: 22.2
Length: 150/180/200/250/
280/300/400/450mm
Finish: CP/ED/SF/AL/COLOR



XW-SP-05

Material: Steel
Diameter: 22.2*25.4
Length: 150/180/200/220/250/
280/300/400/450mm
Finish: CP/ED/SF/AL/COLOR





XW-GR-01

Material: PVC
Size: 105mm
Φ22.2mm



XW-GR-02

Material: PVC
Size: 100mm
Φ22.2mm



XW-GR-03

Material: PVC
Length: 100mm



XW-GR-04

Material: PVC
Size: 110mm
Φ22.2mm



XW-GR-05

Material: PVC/TPE
Size: 120mm(L)
[Φ22.2mm](D)
Color: To Order



XW-GR-06

Material: PVC/TPE
Size: 125mm(L)
[Φ22.2mm](D)
Color: To Order



XW-GR-07

Material: PVC/TPE
Size: 116mm(L)
[Φ22.2mm](D)
Color: To Order



XW-GR-08

Material: PVC/TPE
Size: 120mm(L)
[Φ22.2mm](D)
Color: To Order



XW-GR-09

Material: PVC/TPE
Size: 110mm(L)
[Φ22.2mm](D)
Color: To Order



XW-GR-10

Material: PVC/TPR
Size: 122mm(L)
[Φ22.2mm](D)
Color: To Order



XW-GR-11

Material: PVC/TPE
Size: 98mm(L)
[Φ22.2mm](D)
Color: To Order



XW-GR-12

Material: PVC/TPE
Size: 125mm(L)
[Φ22.2mm](D)
Color: To Order



XW-GR-13

Material: PVC/TPE
Size: 122mm(L)
[Φ22.2mm](D)
Color: To Order



XW-GR-14

Material: PVC/TPE
Size: 120mm(L)
[Φ22.2mm](D)
Color: To Order



XW-GR-15

Material: PVC/TPE
Size: 105mm(L)
[Φ22.2mm](D)
Color: To Order



XW-GR-16

Material: PVC/TPE
Size: 130mm(L)
[Φ22.2mm](D)
Color: To Order



XW-GR-17

Material: PVC
Size: 120mm(L)
[Φ22.2mm](D)
Color: To Order



XW-GR-18

Material: PVC/TPE
Size: 120mm(L)
[Φ22.2+24mm](D)
Color: To Order



XW-GR-19

Material: PVC/TPE
Size: 120mm(L)
[Φ22.2mm](D)
Color: To Order



XW-GR-20

Material: PVC
Size: 115mm(L)
[Φ22.2mm](D)
Color: To Order



XW-GR-21

Material: PVC/TPE
Size: 91mm(L)
[Φ19mm](D)
Color: To Order



XW-GR-22

Material: PVC/TPE
Size: 110mm(L) [Φ22.2mm]
(D)FOR 16#18#20#
Color: To Order



XW-GR-23

Material: PVC/TPE & ALLOY
Size: 135mm(L)
[Φ22.2+24mm](D)
Color: To Order



XW-GR-24

Material: PVC/TPE & ALLOY
Size: 135mm(L)
[Φ22.2+24mm](D)
Color: To Order



XW-GR-25

Material: PVC & ALLOY
Size: 140mm(L)
[Φ22.2mm](D)
Color: To Order



XW-GR-26

Material: PVC/TPE/ABS
Size: 122mm(L)
[Φ22.2mm](D)
Color: To Order



XW-GR-27

Material: RUBBER FOAM
Size: 127mm(L)
[Φ22.2mm](D)
Color: To Order



XW-GR-28

Material: RUBBER FOAM
Size: 127mm(L)
[Φ22.2mm](D)
Color: To Order



XW-GR-29

Material: PVC/TPE/ABS
Size: 127mm(L)
[Φ22.2mm](D)
Color: To Order



XW-GR-30

Material: PVC/TPE
Size: 122mm(L)
[Φ22.2mm](D)
Color: To Order



XW-GR-31

Material: RUBBER FOAM
Size: 127mm(L)
[Φ22.2mm](D)
Color: To Order



XW-GR-32

Material: RUBBER FOAM
Size: 216mm(L)
[Φ22.2mm](D)*4PCS
Color: To Order



XW-GR-33

Material: RUBBER FOAM
Size: 216mm(L)
[Φ22.2mm](D)*4PCS
Color: To Order



XW-GR-34

Material: RUBBER FOAM
Size: 216mm(L)
[Φ22.2mm](D)*4PCS
Color: To Order



XW-BL-01
Advanced steel brake rod
2. Pull fingers sideways



XW-BL-02
Material:reinforced resin,steel insert lever,steel bracket
suitable for:3 finger,lady bike



XW-BL-03
4fingers nylon-compsite lever& bracket with steel insertion and return spring



XW-BL-04
4fingers nylon-compsite lever& bracket with steel insertion and return spring



XW-BL-05
3fingers nylon-compsite lever& bracket with steel insertion and return spring



XW-BL-06
2-3fingers nylon-compsite lever& bracket with steel insertion and return spring



XW-BL-07
4fingers nylon-compsite lever& bracket with steel insertion and return spring



XW-BL-08
4fingers nylon-compsite lever& bracket with steel insertion and return spring



XW-BL-09
2-3fingers nylon-compsite lever& bracket with steel insertion and return spring



XW-BL-10
Material=light-alloy lever,reinforced resin bracket
suitable for 3/4 fingers,return spring



XW-BL-11
Material:light-alloy
Suitable 3/4fingers,return spring



XW-BL-12
Material:light-alloy
Suitable for v-brake 2/3fingers, return spring



XW-BL-13

Material: light-alloy
Suitable for V-brake 2/3 fingers,
return spring



XW-BL-14

Material: light-alloy lever, reinforced
resin bracket
Suitable for 3/4 fingers, return spring



XW-BL-15

Material: light-alloy
Suitable 2/3 fingers, return spring



XW-BL-16

Material: light-alloy
Suitable for V-brake 2/3 fingers,
return spring



XW-BL-17

Material: light-alloy
Suitable for V-brake 2/3 fingers,
return spring



XW-BL-18

Material: reinforced resin,
steel insert lever, steel bracket.
suitable for: 4 fingers, return spring.



XW-BS-01

Size: L=70mm
Inclination: 0°



XW-BS-02

Size: L=70mm
Inclination: 0°



XW-BS-03

Size: L=50mm
Inclination: 0°



XW-BS-04

Size: L=35mm
Inclination: 0°



XW-BS-05

Size: L=40mm
Inclination: 8°



XW-BS-06

Size: L=50mm
Inclination: 8°



XW-BS-07

Size: L=60mm
Inclination: 0°



XW-BS-08

Size: L=35/40mm
Inclination: 8°



XW-BS-09

Size: L=48mm
Inclination: 0°



XW-BS-10

Size: L=50mm
Inclination: 8°



XW-BB-26''



XW-BB-28''



XW-V1

Steel-reinforced nylon composite
V-brake arms
Dual spring tension adjustment
Arm length(m/m): 110mm
Brake shoes:50mm,60mm,70mm



XW-V2

Steel-reinforced nylon composite
V-brake arms
Dual spring tension adjustment
Arm length(m/m): 110-115mm
Brake shoes:50mm,60mm,70mm



XW-V3

Steel-reinforced nylon composite
V-brake arms
Dual spring tension adjustment
Arm length(m/m): 110mm
Brake shoes:50mm,60mm,70mm



XW-V4

Material: steel,ed,cp
Dual linear spring tension
Adjustment
Dual spring tension adjustment
Arm length(m/m): 110-115mm
Brake shoes:50mm,60mm,70mm



XW-V5

Material:steel v-brake
Arm length:110mm
Standard color:ED,CP,COLOR
Rubber pad:55-70mm



XW-V6

Material: light alloy
Dual linear spring tension adjustment
Color: to order
Arm length(m/m): 110mm
Brake shoes:50mm,60mm,70mm



XW-V7

Material: light alloy
Dual linear spring tension adjustment
Color: to order
Arm length(m/m): 110-115mm
Brake shoes:50mm,60mm,70mm



XW-V-SET



XW-CTL-SET



XW-CTL1
Steel cantilever brake arms
Finish: C.P.,ED Black
Brake shoes:50-60mm



XW-CTL2
Materials: reinforced resin,
Steel core cantilever brake
Brake shoes length: 50-60mm



XW-CTL3
Material: Light alloy
Sealed return spring,
quick-adjust brake shoes
Color:to order



XW-CTL4
Nylon with steel-reinforced
insertion cantilever brake arms
Brake shoes:50-60mm



XW-BC-1

A: $\phi 8 \times 11$ head 2.0mm cable
B: $\phi 8 \times 8$ head 2.0mm cable
C: $\phi 6 \times 10$ head 1.5mm cable
D: $\phi 7 \times 7$ head 1.5mm cable
E: $\phi 6 \times 7$ head 1.5mm, 1.35mm cable
F: $\phi 3 \times 4$ head 1.2mm cable



XW-BC-5



XW-BC-2

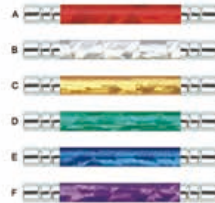

XW-BC-3

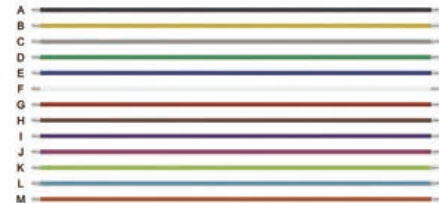

XW-BC-4

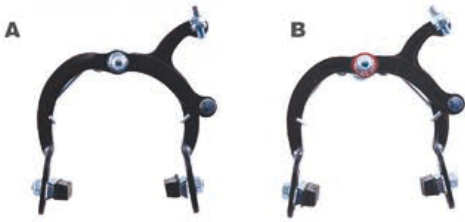

XW-CLP-1
Steel-reinforced caliper
brake arms,side pull.
Finish:ed black or cp.

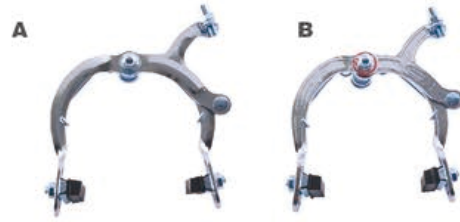

XW-CLP-2
Steel-reinforced caliper
brake arms,side pull.
Finish:ed black or cp.

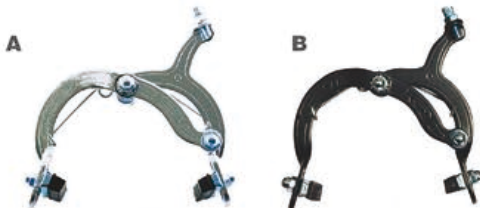

XW-CLP-3
Steel-reinforced caliper
brake arms,side pull.
Finish:ed black or cp.



XW-CLP-4 **XW-CLP-5**



XW-CLP-6 **XW-CLP-7**



XW-DSK
Mechanical Disc brake
caliper
material:aluminum
single pad adjustment
Compatible with post mount
internantional standard 51mm/post mount:74mm
avaible color:black/white/silver
option:f:180mm/160mm
R:160mm/140mm
PAD:NON-asbestos,semi metallic pads



XW-CLP-8



XW-CLP-9



XW-RMB-1



XW-RMB-2



XW-BND-01

Suitable: 24" -28" Adult bicycle
 Drum diam: Out dia of brake disc 90mm
 Screw tye: Both English and Metric
 Finish: CP



XW-BND-02

Suitable: 24" -28" Adult bicycle
 Drum diam: Out dia of brake disc 90mm
 Screw tye: Both English and Metric
 Finish: ED



XW-BND-03

Suitable: Children' cart' small wheel folding cart
 Drum diam: Out dia of brake disc 80mm
 Screw tye: Both English and Metric
 Finish: CP



XW-BND-04

Suitable: Children' cart' small wheel folding cart
 Drum diam: Out dia of brake disc 80mm
 Screw tye: Both English and Metric
 Finish: ED



XW-BND-05

Suitable: Kids bicycle
 Drum diam: Out dia of brake disc 70mm
 Screw tye: Both English and Metric
 Finish: CP



XW-BND-06

Suitable: Kids bicycle
 Drum diam: Out dia of brake disc 60mm
 Screw tye: Both English and Metric
 Finish: ED

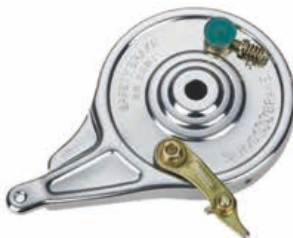

XW-BND-07

Suitable: 20-35km/h
 Drum diam: Inner brake plate 100mm
 Screw tye: Both English and Metric
 Finish: CP



XW-BND-08



XW-BND-09



XW-SFT-01

NON-INDEX THUMB SHIFTER ALLOY
SUITABLE FOR 18-21 SPEEDS
INSTALL DIAMETER: 22.2 MM Φ
STANDARD COLOR: UCP, ALUMINUM COLOR, BLACK



XW-SFT-02

NON-INDEX THUMB SHIFTER ALLOY
SUITABLE FOR 18-21 SPEEDS
INSTALL DIAMETER: 22.2 MM Φ
STANDARD COLORS: UCP,CP



XW-SFT-03

NON-INDEX THUMB SHIFTER PLASTIC
SUITABLE FOR 18-21 SPEEDS
INSTALL DIAMETER: 22.2 MM Φ
STANDARD COLOR: UCP, BLACK



XW-SFT-04

INDEX THUMB SHIFTER PLASTIC
LEFT:3 SPEED INDEX;
RIGHT:6.7 SPEED INDEX
CLAMP DIAM: Φ 22.2MM



XW-SFT-05

NON-INDEX REVO-SHIFTER
SUITABLE FOR 18-21 SPEEDS
INSTALL DIAMETER: 22.2 MM Φ
STANDARD COLOR: RED AND BLACK



XW-SFT-06

NON-INDEX REVO-SHIFTER
SUITABLE FOR 18-21 SPEEDS
INSTALL DIAMETER: 22.2 MM Φ
STANDARD COLOR: RED AND BLACK



XW-SFT-07

NON-INDEX REVO-SHIFTER
SUITABLE FOR 18-21 SPEEDS
INSTALL DIAMETER: 22.2 MM Φ
STANDARD COLOR: RED AND BLACK



XW-SFT-08

NON-INDEX REVO-SHIFTER
SUITABLE FOR 18-21 SPEEDS
INSTALL DIAMETER: 22.2 MM Φ
STANDARD COLOR: RED AND BLACK



XW-SFT-09

ALLOY THUMB SHIFER,
LEFT&RIGHT 7,8 INDEX
MATERIAL: ALLOY/RESIN
CLAMP DIAM: Φ 22.2MM
PACKING: 25PRS/CTN
G.W./N.W.: 15/14KG
MEAS: 54*26*27.5CM



XW-FD-01

NON-INDEX TOP PULL
SUITABLE FOR 15-21 SPEEDS
CLAMP RING DIAMETER: 28.6 Φ Φ 31.8 MM
STANDARD COLORS: CP,UP,ED
IT IS SUITABLE FOR 3-STAGE PRESSURE DISC
WITH A MAXIMUM TOOTH DISC OF 48T
FEATURES: STEEL



XW-FD-02

NON-INDEX TOP PULL
SUITABLE FOR 10-12 SPEEDS
CLAMP RING DIAMETER: 28.6 Φ Φ 31.8 MM
STANDARD COLORS: CP,UP,ED
SUITABLE FOR 2 STAGE PRESSURE DISC,
MAXIMUM TOOTH DISC 42T
FEATURES: STEEL



XW-FD-03

NON-INDEX DOWN PULL
SUITABLE FOR 15-21 SPEEDS
CLAMP RING DIAMETER: 28.6 Φ Φ 31.8 MM
STANDARD COLORS: CP,UP,ED
IT IS SUITABLE FOR 3-STAGE PRESSURE DISC
WITH A MAXIMUM TOOTH DISC OF 48T
FEATURES: STEEL



XW-FD-04

NON-INDEX DOWN PULL
SUITABLE FOR 10-12 SPEED
CLAMP RING DIAMETER: 28.6 Φ Φ 31.8 MM
STANDARD COLOR :CP,UCP,ED
SUITABLE FOR 2 STAGE PRESSURE PLATE
THE MAXIMUM TOOTH DISC IS 42T
FEATURES: STEEL



XW-FD-05

NON-INDEX TOP PULL
SUITABLE FOR 15-21 SPEEDS
CLAMP RING DIAMETER: 28.6 Φ Φ 31.8 MM
STANDARD COLORS: CP,UP,ED
IT IS SUITABLE FOR 3-STAGE PRESSURE DISC
WITH A MAXIMUM TOOTH DISC OF 48T
FEATURES: STEEL



XW-FD-06

NON-INDEX TOP PULL
SUITABLE FOR 15-21 SPEEDS
CLAMP RING DIAMETER: 28.6 Φ Φ 31.8 MM
STANDARD COLORS: CP,UP,ED
IT IS SUITABLE FOR 3-STAGE PRESSURE DISC
WITH A MAXIMUM TOOTH DISC OF 42T
FEATURES: STEEL



XW-RD-07

NON-INDEX 18/21S
SPEED BACK PULL, LONG ARM
INSTALLATION: WITH PATCH
FEATURES: STEEL
TOOTH CAPACITY: 36T
STANDARD COLORS: CP,UP,ED



XW-RD-08

NON-INDEX 12S
SHORT CAGE, WITH BRACKET
FEATURE: STEEL CP,UCP,ED
TOTAL CAPACITY: 28T



XW-RD-09

NON-INDEX 12S
BACK PULL, LONG ARM
INSTALLATION: DIRECT INSTALLATION
FEATURES: STEEL
TOOTH CAPACITY: 28T
STANDARD COLORS: CP,UP,ED



XW-RD-10

INDEX 21/24S
INSTALLATION: WITH PATCH
FEATURES: STEEL
TOOTH CAPACITY: 43T
STANDARD COLORS: CP,UCP,ED



XW-RD-11

INDEX 18/21S
INSTALLATION: DIRECT INSTALLATION
FEATURES: STEEL
TOOTH CAPACITY: 36T
STANDARD COLORS: CP,UCP,ED



XW-RD-12

INDEX 7S
LONG ARM, WITH LONG CONNECTOR
FEATURES: STEEL, RESIN
TOOTH CAPACITY: 38T



XW-DRS-01



XW-DRS-02



XW-DRS-03



XW-DRS-04



XW-DRS-05



XW-DRS-06

XW-BBA-1



Cottered axle

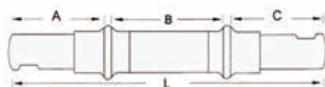

Bracket width	A	B	C	Axle Length
68	35	52	46	133
68	40	52	46	138
68	41	52	46	139
68	43	52	48	143
68	43	52	52	147
68	45	52	50	147
68	45	52	51	148
68	48	52	51	151
68	50	52	50	152
68	50	52	52	154
70	40	55	48	143
70	41	55	49	145
70	41	55	51	147
70	43	55	48	146
70	43	55	51	149
70	45	55	45	145
70	48	55	48	151
70	50	55	50	155
70	51	55	51	157
70	50	55	52	157

XW-BBA-2



Nut Type Cotterless axle

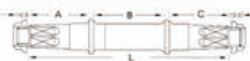

Bolt Type Cotterless axle



Model	Bracket width	A	B	C	Axle Length
3H	68	28	52	27	107
3M	68	28	52	28	108
3E	68	28	52	30.5	110.5
3J	68	30.5	52	30.5	113
3C	68	30.5	52	32	114.5
3L	68	32	52	32	116
3A	68	32	52	33.5	117.5
3P	68	32	52	35	119
3N	68	32	52	36	120
3SS	68	32	52	37.5	121.5
3Z	68	33.5	52	33.5	119
3PL	68	35	52	35	122
3S	68	35	52	37.5	124.5
3T	68	35	52	39	126
3U	68	35	52	40.5	127.5
3R	68	35	52	42	129
3UM	68	37.5	52	40.5	130
3RM	70	37.5	52	42	131.5
5L	70	32	54	32	118
5P	70	32	54	35	121
5S	70	35	54	37.5	126.5
5T	70	35	54	39	128
5U	70	35	54	40.5	129.5
5R	70	32	54	42	131
7L	73	32	57	32	121
7P	73	32	57	35	124
7S	73	35	57	37.5	129.5
7T	73	35	57	39	131
7U	73	35	57	40.5	132.5
7R	73	35	57	42	134

XW-BBA-3

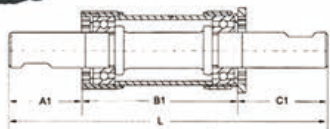

Components:Crmo&10B21 cottered spindle
Steel Body 2pcs Steel cups,
2pcs Sealed bearings
Bearing:16*31*10mm
Thread:1.37*24TL/R
Finish:ED/CP
Applications: MTB.ROAD

Bracket Width	A1	B1	C1	L
68	33	68	41	142
68	41	68	43	152
70	41	70	44	155
73	29	73	40	142
78	31	78	41	150
80	31	80	39	150

XW-BBA-4



AXLE LENGTH 中轴长度 L	B. B. SHELL WIDTH-68mm 五通管宽度 68mm			
	A	B	C	D
103.0	17.0	68	18.0	52.0
110.5	22.0	68	20.5	54.5
113.5	22.5	68	23.0	57.0
115.0	23.0	68	24.0	58.0
118.0	25.0	68	25.0	59.0
119.0	24.0	68	27.0	61.0
122.5	26.0	68	28.5	62.5
127.5	28.5	68	31.0	65.0
131.0	29.0	68	34.0	68.0
133.0	32.5	68	32.5	66.5
167.0	21.5	120	26	86



XW-BBS-1



XW-BBS-2



XW-BBS-3



XW-BBS-4



XW-BBC-1

Ball Retainer(1/4" *9)
Thread BC1.375" *24T
Set 5PCS



XW-BBC-2

Ball Retainer(1/4" *9)
Thread BC1.375" *24T
Set 6PCS



XW-BBC-3

Ball Retainer(1/4" *9)
Thread BC1.375" *24T
Set 5PCS



XW-BBC-4

Ball Retainer(1/4" *9)
Thread BC1.375" *24T
Set 6PCS



XW-BBC-5

Ball Retainer(1/4" *9)
Thread BC1.375" *24T
Set 5PCS



XW-BBC-6

Ball Retainer(1/4" *9)
Thread BC1.375" *24T
Set 5PCS



XW-BBC-7

Ball Retainer(1/4" *9)
Thread BC1.375" *24T
Set 5PCS



XW-BBC-8

Material: Steel
Bearing: 16*31*10mm
Thread: 1.37" *24TL/R
Finish: ED/CP Set: 4pcs



XW-SB

Steel ball: 1/4 3/16 5/32 5/16



XW-BBC-9

Material: Steel.Set 9 pcs
Ball retainer: 5/16" *7*2pcs
Cup OD: Φ 43.1mm
Thread: 3/4" *24tl 13/16" *24T R
Finish: ED/UCP



XW-BBC-10

Material: Steel.Set 9 pcs
Ball retainer: 5/16" *9*2pcs
Cup OD: Φ 51.5mm*2pcs
Thread: 7/8" *24tl 15/16" *24T R
Finish: ED/UCP



5/32*16 5/16*9 1/4*7 3/16*7

XW-BCG





XW-HUB-01

shell: steel
spoke hole: 32H
AXLE: 5/16



XW-HUB-02

shell: steel
spoke hole: 40H
AXLE: 3/8



XW-HUB-03

shell: steel MTB
spoke hole: 20H 28H 32H 36H
AXLE: 3/8



XW-HUB-04

shell: steel
spoke hole: 20H 28H 32H 36H
AXLE: 5/16 3/8



XW-HUB-05

shell: steel
spoke hole: 20H 28H 32H 36H
AXLE: 3/8



XW-HUB-06

shell: steel
spoke hole: 20H 28H 32H 36H
AXLE: 3/8



XW-HUB-07

shell: steel
spoke hole: 28H 32H 36H
AXLE: 3/8



XW-HUB-08

shell: steel
spoke hole: 28H 32H 36H
AXLE: 3/8



XW-HUB-09

shell: Alloy
spoke hole: 28H 32H 36H
AXLE: 3/8



XW-HUB-10

shell: Alloy
spoke hole: 28H 32H 36H
AXLE: 3/8



XW-HUB-11

shell: Alloy
spoke hole: 28H 32H 36H
AXLE: 3/8



XW-HUB-12

shell: Alloy MTB
spoke hole: 28H 32H 36H
AXLE: 3/8



XW-HUB-13

shell: Alloy
spoke hole: 28H 32H 36H
AXLE: 3/8



XW-HUB-14

shell: Alloy MTB
spoke hole: 28H 32H 36H
AXLE: 3/8



XW-HUB-15

shell: steel
spoke hole: 36H
AXLE: 3/8



XW-HUB-16

shell: steel
spoke hole: 36H
AXLE: 3/8



XW-HUB-17

shell: steel
spoke hole: 16H 20H 28H
32H 36H 40H
AXLE: 3/8



XW-HUB-18

CUP
A: FRONT FLANGE CUP 5/16" -26-Φ24.5
B: REAR FLANGE CUP 3/8" -26-Φ29.2
Surface treatment:ED/UCP



XW-CAD-1



XW-CAD-2



XW-CPN 9.8/ 9.5/9.3/9.0



XW-6200



XW-6000



XW-6203



XW-6004



XW-6003



XW-6002



XW-6009



XW-6903



XW-HP-01

Material: steel, set of 8pcs
 Height: 33/cup type
 Size: 1" *24T
 Diameter: $\Phi 22.2 \times 30 \times 27$
 $\Phi 22.2 \times 30 \times 26.4$
 Finish: CP&ED&RED&BLUE
 Bearings: 5/32" *16*2pcs



XW-HP-02

Material: steel, set of 8pcs
 Size: 1" *24T
 Diameter: 1" *30*27
 Finish: CP&ED
 Bearings: 5/32" *16*2pcs



XW-HP-03

Material: steel, set of 5pcs
 Height: 32/cup type
 Size: 1" *24T
 Diameter: $\Phi 22.2 \times 30 \times 27$
 Finish: CP&ED
 Bearings: 3/16" *16



XW-HP-04

Material: steel, set of 8pcs
 Size: 1" *24T
 Diameter: 1" *30*27
 Finish: CP&ED
 Bearings: 5/32" *16*2pcs



XW-HP-05

Material: steel, set of 8pcs
 Height: 34/cup type
 Size: 1" *24T
 Diameter: $\Phi 22.2 \times 32.5 \times 27$
 Finish: CP&ED
 Bearings: 5/32" *16*2pcs



XW-HP-06

Material: steel, set of 8pcs
 Height: 34/cup type
 Size: 1" *24T
 Diameter: $\Phi 22.2 \times 34 \times 27$
 Finish: CP&ED
 Bearings: 5/32" *16*2pcs



XW-HP-07

Material: steel, set of 8pcs
 Height: 34/cup type
 Size: 1" *24T
 Diameter: $\Phi 22.2 \times 30 \times 27$
 Finish: CP&ED
 Bearings: 5/32" *16*2pcs



XW-HP-08

Material: alloy+steel, set of 9pcs
 Height: 28.5/cup type
 Size: 1-1/8" threadless
 Diameter: 1-1/8" *34*30
 Finish: CP&ED
 Bearings: 5/32" *20*2pcs



XW-HP-09

Threadless Semi-Integrated headset
Material: alloy+steel,set of 10pcs
Height: 9mm
Size: 1-1/8" threadless
semi-integrated headset
with $\Phi 44$ steel cups
Diameter: 1-1/8" *44*30
Finish: CP&ED
Bearings: caged(5/32" *20*2pcs



XW-HP-10

Threadless Semi-Integrated headset
Material: alloy+steel,set of 6pcs
Height: 9.5mm
Size: 1-1/8" threadless
semi-integrated headset
with $\Phi 44$ steel cups
Diameter: 1-1/8" *44*30
Finish: CP&ED
Bearings: caged(5/32" *20*2pcs



XW-HP-11

Threadless Semi-Integrated headset
Material: alloy+steel,set of 11pcs
Height: 23mm
Size: 1-1/8"
Diameter: 1-1/8" *44*30
Finish: anodized black or silver
Bearings: caged(5/32" *20*2pcs



XW-HP-12

Threadless Semi-Integrated headset
Material: alloy+steel,set of 8pcs
Height: 23mm
Size: 1-1/8"
Diameter: 1-1/8" *44*30
Finish: anodized black or silver
Bearings: sealed cartridge
(6.5h*41* $\Phi 30.2$ *45° *2pcs)



XW-HP-13

Threadless Semi-Integrated headset
Material: alloy+steel,set of 8pcs
Height: 23mm
Size: 1-1/8" threadless
semi-integrated headset
with $\Phi 44$ steel cups
Diameter: 1-1/8" *44*30
Finish: anodized black or silver
or optional color
Bearings: sealed cartridge
(6.5h*41* $\Phi 30.2$ *45° *2pcs)



XW-HP-14

Intergrated threadless headset
with water seals
cartridge alloy cups alloy top cover
Material: steel,alloy set of 8pcs
Height: 8mm
Size: 1-1/8" threadless
semi-integrated headset
Diameter: 1-1/8"
Finish: anodized black or silver
Bearings: sealed cartridge
(6.5h*41* $\Phi 30.2$ *45° *2pcs)



XW-HP-15

Material: steel,set of 7pcs
Size: M25*1
Diameter: M25*30*27
Finish: UCP/CP/BLACK
Bearings: Caged5/32" *20*2pcs



XW-HP-16

Material: steel,set of 7pcs
Size: M25*1
Diameter: M25*30*33*30
Finish: UCP/CP/ED
Bearings: 5/32" *20*2pcs
5/32" *21*1pcs





XW-CWC-01
DOUBLE SHIELD
TEETH:36T*165MM



XW-CWC-02
Size:48t/52t
152/165/170mm



XW-CWC-03
TEETH:44t*165MM



XW-CWC-04
TEETH:44t*165MM



XW-CWC-05
TEETH:steel 136,38,40,42,44,46,48t
Crank:steel forged 88,102,114,127,140,152,165,170mm



XW-CWC-06
TEETH:44T*165MM



XW-CWC-07
TEETH:46T*170MM



XW-CWC-08
TEETH:48T*175MM



XW-CWC-09
TEETH:36t*165MM



XW-CWC-10
TEETH:46t*165MM



XW-CWC-11
TEETH:48T*170MM



XW-CWC-12
TEETH:46T*165MM



XW-CWC-13
TEETH:44T/46T/48T
165/170MM



XW-CWC-14
TEETH:28T/32T/36T
89/114/127MM



XW-CWC-15
TEETH:44T/46T/48T
165/170MM



XW-CWC-16
TEETH:32T*165MM



XW-CWC-17
TEETH:32T*165MM



XW-CWC-18
TEETH:36T*165MM



XW-CWC-19
TEETH:36T*165MM



XW-CWC-20
TEETH:46T/48T*165/170MM



XW-CWC-21
TEETH:46T/48T*165/170MM



XW-CWC-22
TEETH:46T/48T*165/170MM



XW-CWC-23
TEETH:28/38/48*165MM



XW-CWC-24
TEETH:28/38/48*165MM



XW-CWC-25
Size:019 28T 38T 48T
TEETH:170mm



XW-CWC-26
TEETH:28/38/48*165MM



XW-CWC-27
TEETH:28/38/48*165MM



XW-CWC-28
Size:40t/44t/46t/48t
152/165/170/175mm



XW-CWC-29
Size:28t/38t/48t
165/170/175mm



XW-CWC-30
TEETH:28/38/48*165MM



XW-CWC-31
TEETH:24/34/42*165MM



XW-CWC-32
TEETH:steel24-34-42t
Crank:steel forged crank with
plastic coated 152,170mm



XW-CWC-33
TEETH:steel 142/52t
Crank:steel forged 170mm



XW-CWC-34
TEETH:steel 28-37-48t
Crank:steel forged 170mm
Spider:plastic g-09
Chainguard:plastic P-19



XW-CWC-35
TEETH:steel 36,38,40,42,44,46,48t
Crank:steel forged 127,140,152,165,170mm
Chainguard:plastic



XW-CWC-36
Steel triple chainwheel of opc
Size:1/2" *3/32"
Teeth:28/38/48t Color to order



XW-CW-1
Size:1/2" *3/32"
Teeth:28t,32t,48t
finish:cp/ed



XW-CW-2
NO.21U-4, 40T, 44T, 46T, 52T



XW-CW-3
NO.51U-5 28T,32T,
36T,40T,44T,46T



XW-CW-4
NO.21U-6 40T 44T



XW-CW-5
Teeth:28t,32t,36t,40t,44t,46t
finish:cp/ed



XW-CW-6
Teeth:28t,32t,36t,40t,44t,46t
finish:cp/ed



XW-CW-7
Teeth:28t,32t,36t,40t,44t,46t
finish:cp/ed



XW-OPC-1
Teeth:R-13/16*24T L-3/4*24T
Size:89/102/114/127/140MM



XW-OPC-2
Teeth:R-15/16*24T L-7/8*24T
Size:89/102/114/127/140/
152/165/170MM



XW-OPC-3
Teeth:R-15/16*24T L-7/8*24T
Pin Pitch: 34(Φ9.5)
Size:89/102/114/127/140/
152/165/170MM



XW-OPC-4
Teeth:R-23.2*32T L22*24T
Pin Pitch: 41(Φ11)
Size:89/102/114/127/140/
152/165/170MM



XW-OPC-5
Teeth:R-13/16*24T L-3/4*24T
Pin Pitch: 34(Φ9.5)
Size:114/127/145/160MM



XW-CN-1

Size: 1/2" *1/8"
Pin length:8.6mm
Speed of Sprocket:1
Tensile Strength(min):820kgf



XW-CN-2

Size: 1/2" *3/32"
Pin length:7.6mm
Speed of Sprocket:6
Tensile Strength(min):820kgf



XW-CN-3

Size: 1/2" *3/32"
Pin length:7.3mm
Speed of Sprocket:7
Tensile Strength(min):860kgf



XW-CN-4

Size: 1/2" *3/32"
Pin length:7.1mm
Speed of Sprocket:8
Tensile Strength(min):860kgf



XW-CN-5

Size: 1/2" *11/128"
Pin length:6.6mm
Speed of Sprocket:9
Tensile Strength(min):920kgf



XW-CN-6

Size: 1/2" *11/128"
Pin length:6.0mm
Speed of Sprocket:10
Tensile Strength(min):920kgf



XW-CC-1



XW-CC-2



XW-CC-3



XW-CC-4





XW-FW-01



XW-FW-02



XW-FW-03

Cold-forged with
4 removal spines
Size:1/2" *1/8" -16T
Material:A3-20
Finish:Brown or cp
Thread:B1.375*24T



XW-FW-04

Size:1/2" *1/8" -18T
Material:A3-20
Finish:Brown or cp
Thread:B1.375*24T



XW-FW-05

Size:1/2" *1/8" -20T
Material:A3-20
Finish:Brown or cp
Thread:B1.375*24T



XW-FW-06

Size:1/2" *1/8" -22T
Material:A3-20
Finish:Brown or cp
Thread:B1.375*24T



XW-FW-07

Size:1/2" *1/8" -24T
Material:A3-20
Finish:Brown or cp
Thread:B1.375*24T



XW-FW-08

5 Speed Non-index freewheel
Finish:black/brown.cp
Standard:14T-28T,M1.375-24T



XW-FW-09

6 Speed Non-index freewheel
Finish:black,brown.cp
Standard:12T-28T,M1.375-24T



XW-FW-10

7 Speed Index freewheel
Finish:black/brown.cp
Standard:14T-28T,M1.375-24T



XW-FW-11

8 Speed Index freewheel
Finish:black/brown.cp
Standard:12T-28T,M1.375-24T



XW-FW-12

9 Speed Index freewheel
Finish:black/brown.cp
Standard:12T-32T,M1.375-24T



XW-FW-13

10 Speed Index freewheel
Finish:black/brown.cp
Standard:11T-32T,M1.375-24T





XW-FK-01
Size: 12-26



XW-FK-02
Size: 26/27



XW-FK-03
Size: 26/28



XW-FK-04
Size: 26/28



XW-FK-05
Size: 26/28



XW-FK-06
Size: 12-26



XW-FK-07
Size: 12-26



XW-FK-08
Size: 12-26



XW-FK-09



XW-FK-10
Size: 12-26



XW-FK-11
Size: 12-26



XW-FK-12
WHEEL SIZE:26/24
CROWN:STEEL CROWN
STANCHIONS:25.4*1.8T
OUTER LEG:31.8*1.2T
BRAKE TYPE:V-BRAKE
CROWN PITCH:107MM



XW-FK-13
Size: 12-26



XW-FK-14
Size: 12-26





XW-MG-01



XW-MG-02



XW-MG-03



XW-MG-04



XW-MG-05



XW-MG-06



XW-MG-07



XW-MG-08



XW-MG-09



XW-MG-10



XW-MG-11



XW-MG-12



XW-MG-13



XW-MG-14



XW-MG-15



XW-MG-16



XW-MG-17



XW-MG-18



XW-MG-19



XW-MG-20

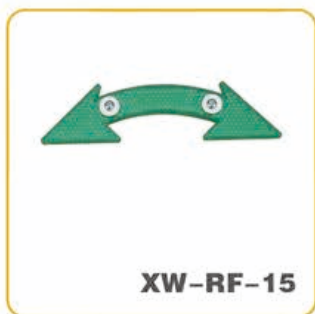
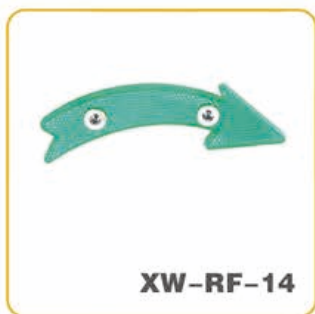
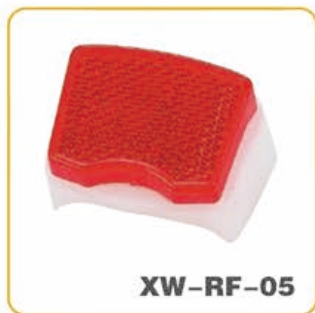
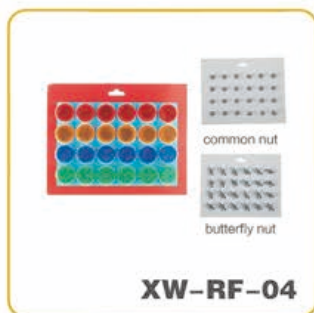



XW-SW-01
5"
Plastic wheel/PVC Tire



XW-SW-02
5"
Plastic wheel/Rubber Tire



XW-SW-03
4.5"
Plastic wheel



XW-SW-04
5"
Plastic wheel/Rubber Tire



XW-SW-05
4.5"
Plastic wheel/PVC Tire



XW-SW-06
4.3"
Plastic wheel/Rubber Tire



XW-SW-07
4"
Plastic wheel/PVC



XW-SW-08
5.5"
Plastic wheel/PVC Tire



XW-SW-09
5"
Plastic wheel/Rubber Tire



XW-SW-10
4.5"
Plastic wheel/Rubber Tire



XW-SW-11
5"
Plastic wheel/Rubber Tire



XW-SW-12
4.9"
Plastic wheel/Rubber Tire



XW-SWS-1
12" /14" 16" 18" 20"
Heavy steel plate stay



XW-SWS-2
12" -16" 16" -20"
Heavy steel plate stay



XW-SWS-3
12" -20"
Heavy steel plate stay



XW-SWS-4
12" -20"
Heavy steel plate stay



XW-SWS-5
12" -20"
Heavy steel plate stay



XW-SWS-6
12" -16"
Heavy steel plate stay



XW-SWS-7
12" /14" 16" 18" 20"
Heavy steel plate stay



XW-SWS-8



XW-BE-01



XW-BE-02



XW-BE-03



XW-BE-04



XW-BE-05



XW-BE-06



XW-BE-07



XW-BE-08



XW-BE-09



XW-BE-10



XW-BE-11



XW-BE-12



XW-BE-13



XW-BE-14



XW-BE-15



XW-BE-16



XW-BE-17



XW-BE-18



XW-BE-19



XW-BE-20



XW-EHN-1

Bicycle horn
Specification: 4 siren, 7i flashing horn
Color: white transparent, blue transparent
Battery: AA*2 (not included)



XW-EHN-2

Bicycle horn
Specification: 4 siren, 4 buttons
7 flashing speakers with 1 short cord,
But no iron bars
Color: red
Battery: AA*2 (not included)



XW-EHN-3

Bicycle horn
Specification: 4 siren, 1 button,
7 flashing speakers with 1 short cord,
But no iron bars
Color: red
Battery: AA*2 (not included)



XW-EHN-4

Bicycle horn
Specification: 8 kinds of sound, 1 flashing horn
Color: white transparent, blue transparent
Battery: AA*2 (not included)



XW-EHN-5

Bicycle horn
Specification: 8 sound 1 flashing horn
Color: black, red, yellow, green, blue
Battery: AA*2 (not included)



XW-EHN-6

Bicycle horn
Specification: 8 sound 7 flash horn
Color: black, red, yellow, green, blue
Battery: AA*2 (not included)



XW-EHN-7

Bicycle horn
Specification: 4 kinds of sound, 4 buttons,
Six flashing speakers with short lines
Color: red, white, blue
Battery: AA*2 (not included)



XW-EHN-8

Bicycle horn
Specification: 4 siren,
2 flashing speakers or toys
Colour: red, black and white
Battery: AA*2 (not included)



XW-EHN-9

An alarm sounds when the button is pressed
Battery: AAA*2 (not included)



XW-EHN-10

Bicycle turn signals
Specification: 8 speakers, 9 super bright LED,
Including turn signals, brake lights, night lights
Battery: AA*2 (not included)



XW-EHN-11

Bicycle turn signals
Specification: 8 speakers, 11 super bright LED
The 8 functions include turn signal,
brake light and night light
Battery: AA*2 (not included)



XW-DLS-1



XW-DLS-2



XW-DLS-3



XW-DLS-4



XW-DLS-5



XW-HN-1



XW-HN-2



XW-HN-3



XW-HN-4



XW-HN-5



XW-HN-6



XW-HN-7



XW-HN-8



XW-HN-9



XW-HN-10



XW-HN-11



XW-HN-12





XW-PEG-01
Material: alloy
Size: $\Phi 50 \times 110$ 3/8*26T



XW-PEG-02
Material: Alloy
Size: $\Phi 38 \times 110$ 3/8*26T



XW-PEG-03
Material: alloy
Size: $\Phi 19 \times 75$ 3/8*26T



XW-PEG-04
Material: alloy
Size: $\Phi 28 \times 100$ 3/8*26T



XW-PEG-05
Material: alloy
Size: $\Phi 23 \times 63$ 3/8*26T



XW-PEG-06
Material: Alloy
Size: $\Phi 38 \times 110$ 3/8*26T



XW-PEG-07
Material: steel
Size: $\Phi 50 \times 110$ 3/8*26T/24T



XW-PEG-08
Material: steel
Size: $\Phi 50 \times 110$ 3/8*26T/24T



XW-PEG-09
Material: steel
Size: $\Phi 38 \times 110$ 3/8*26T/24T



XW-PEG-10
Material: steel
Size: $\Phi 38 \times 110$ 3/8*26T/24T



XW-PEG-11
Material: steel
Size: $\Phi 50 \times 110$ M14



XW-PEG-12
Material: alloy
Size: $\Phi 50 \times 110$ 3/8*26T



XW-CP-1



XW-CP-2



XW-CP-3



XW-SS-01



XW-SS-02



XW-SS-03



XW-SS-04



XW-SS-05



XW-SS-06



XW-SS-07



XW-SS-08



XW-SS-09



XW-SS-10



XW-SS-11



XW-SS-12



XW-SS-13



XW-SS-14



XW-SS-15



XW-SS-16



XW-SS-17



XW-SS-18



XW-SS-19



XW-SS-20



XW-SS-21



XW-SS-22



XW-SS-23



XW-SS-24



XW-SS-25



XW-SS-26



XW-SS-27

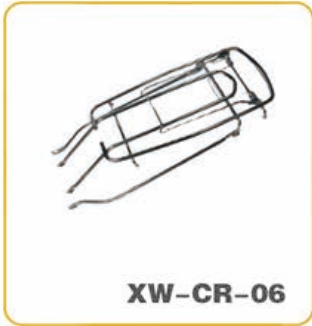
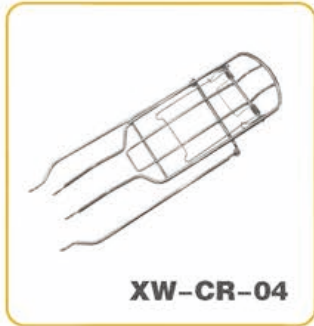

XW-PP-01



SIZE:Φ 22*400mm

XW-PP-02



SIZE:Φ 22*400mm

XW-PP-03



SIZE:32-260

XW-PP-04



SIZE:32-260

XW-PP-05



XW-PP-06



SIZE:38*300

XW-PP-07



SIZE:38-500

XW-PP-08



SIZE:32-500

XW-PP-09



SIZE:38-500

XW-PP-10



SIZE:38-500

XW-PP-11



SIZE:32-500

XW-PP-12



SIZE:35-610

XW-PP-13



SIZE:30*580

XW-PP-14



SIZE:35*590

XW-PP-15



SIZE:35*330

XW-PP-16



SIZE:35-600

XW-PP-17



SIZE:32-260

XW-PP-18



SIZE:30-580

XW-PP-19



SIZE:32*620

XW-PP-20



SIZE:38*580

XW-PP-21



SIZE:38-600

XW-PP-22



SIZE:32-660

XW-PP-23



SIZE:30-300

XW-PP-24



SIZE:30-320

XW-PP-25



SIZE:45*350



XW-PC-01



XW-PC-02



XW-PC-03



XW-PC-04



XW-PC-05



XW-PC-06



XW-PC-07



XW-PC-08



XW-RB-01



XW-RB-02



XW-RB-03



XW-RB-04



XW-RB-05



XW-RB-06



XW-RB-07





XW-LK-01



XW-LK-02



XW-LK-03



XW-LK-04



XW-LK-05



XW-LK-06



XW-LK-07



XW-LK-08



XW-LK-09



XW-LK-10



XW-LK-11



XW-LK-12



XW-LK-13



XW-LK-14



XW-LK-15



XW-LK-16



XW-BKT-01
Size: 39*28*19.5cm



XW-BKT-02
Size: 35*25*26.5cm



XW-BKT-03
Size: 35*25*26.5cm



XW-BKT-04
Size: 35*25*26.5cm



XW-BKT-05
Size: 32*23*22cm



XW-BKT-06
Size: 35*25*25cm



XW-BKT-07
Size: 34*25.5*24cm



XW-BKT-08
Size: 32*25.5*24cm



XW-BKT-09
Size: 32*25.5*24cm



XW-BKT-10
Size: 32*25.5*24cm



XW-BKT-11
Size: 32*25.5*24cm



XW-BKT-12
CTB car basket
Size: 24 * 26.5 * 15.5 cm



XW-BKT-13
Size: 33*22*25cm



XW-BKT-14
Size: 24.5*23*25.5cm



XW-BKT-15
Size: 34*23*26cm



XW-BKT-16
Size: 33*22*25cm



XW-BKT-17
Bamboo basket
Size: 37*23.8*26.5cm



XW-BKT-18
Size: 330*220*250cm



XW-BKT-19
Size: 330*220*250cm



XW-BKT-20
Size: 330*220*250cm



XW-BKT-21
Size: 35*25*26cm



XW-BKT-22
Size: 35-25-26cm



XW-BKT-23
Size: 37*25*24cm



XW-BKT-24



XW-BKT-25
GRAY



XW-BKT-26
Size: 29*23*20cm



XW-BKT-27



XW-BKT-28
Size: 295*270*170mm

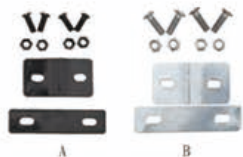

XW-BF-1
Front rim clip



XW-BF-2



XW-BF-3



XW-BF-4



XW-RIM-01

规格: Steel Rims
451-630*18mm
20-27" *1_{1/4}-1_{3/8}

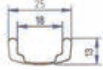

XW-RIM-02

规格: Steel Rims
575*30mm
26" *2.125

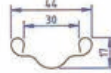

XW-RIM-03

规格: Steel Rims
540-590*22mm
24-26" *1_{3/8}

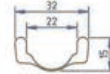

XW-RIM-04

规格: Steel Rims
584-635*25mm
26-28" *1_{1/2}
26" -2*1_{3/4}

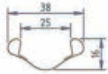

XW-RIM-05

规格: Steel Rims
422-650*22.5mm
20-28" *1_{1/2}

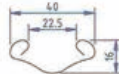

XW-RIM-06

规格: Steel Rims
164-575*25mm
10-26" *1.5-1.75

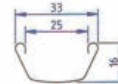

XW-RIM-07

规格: Steel Rims
220-639*25mm
12-28" *1.75-2.125



XW-RIM-08

规格: Steel Rims
220-639*25mm
12-28" *1.75-2.125



XW-RIM-09

规格: Steel Rims
442-575*27mm
20-26" *1.75-2.125

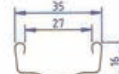

XW-RIM-10

规格: Steel Rims
442-575*27mm
20-26" *1.75-2.125

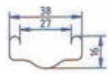

XW-RIM-11

规格: Steel Rims
220-575*20mm
12-26" *1.5-1.75

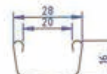

XW-RIM-12

Specification: Steel Rims
220-575*20mm
12-26" *1.5-1.75

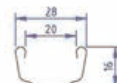

XW-RIM-13

Specification: Steel Rims
220-575*29mm
12-26" *2.125

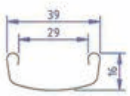

XW-RIM-14

Specification: Steel Rims
220-575*20mm
12-26" *1.5-1.95

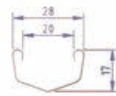

XW-RIM-15

规格: Steel Rims
400-584*28mm
20" *2*1_{3/4}
26" *1_{1/2}

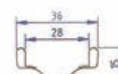

XW-RIM-16

规格: Alloy Rims
16-26" *1.5-1.75"
24-26" *1.38

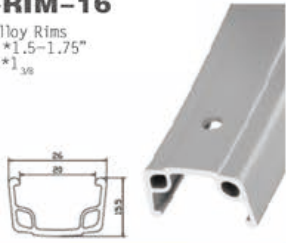

XW-RIM-17

规格: Alloy Rims
16-26" *1.5-1.75"
24-26" *1.38

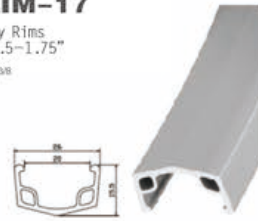

XW-RIM-18

规格: Alloy Rims
24-26" *1.5-1.75"
24-26" *1.38



XW-RIM-19

规格: Alloy Rims
24-26" *1.5-1.75"
24-26" *1.38



XW-RIM-20

规格: Alloy Rims
16-26" *1.5-1.75"
24-26" *1.38

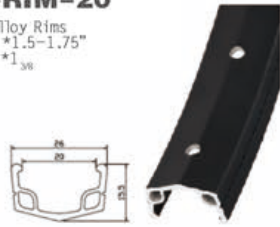

XW-RIM-21

规格: Alloy Rims
16-26" *1.75-2.125"



XW-RIM-22

16*1.75-2.125
14*1.75-2.125
20*1.75-2.125
22*1.75-2.125
24*1.75-2.125
26*1.75-2.125

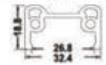

XW-RIM-23

规格: Alloy Rims
700C
24-26" *1.5*1.75"
24-26" *1.38
Height: 25mm/30mm/35mm



XW-SPK-01

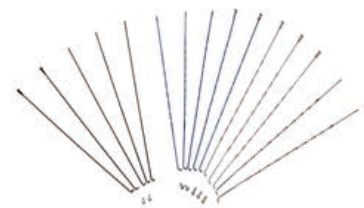

XW-SPK-02



XW-SPK-03



XW-TR-01

26*1 3/8



XW-TR-02

12*1.75
14*1.75
16*1.75
18*1.75
20*1.75



XW-TR-03

12*2.125
14*2.125
16*2.125
20*2.125
24*1.95/2.125
26*1.95/2.125



XW-TR-04

12*1.75/2.125
14*1.75/2.125
16*1.75/2.125



XW-TR-05

12*1.75/2.125
14*1.75/2.125
16*1.75/2.125
20*1.75/2.125
24*1.95/2.125
26*1.95/2.125



XW-TR-06

12*1.75/2.125
14*1.75/2.125
16*1.75/2.125
18*1.75/2.125
20*1.75/2.125
24*1.95/2.125
26*1.95/2.125



XW-TR-07

24*1.75/1.95
26*1.75/1.95



XW-TR-08

12*1.95/2.125
14*1.95/2.125
16*1.95/2.125
18*1.95/2.125
20*1.95/2.125
22*1.95/2.125



XW-TR-09

26*2*1 3/4



XW-TR-10

12*2.125/2.35
14*2.125/2.35
16*2.125
18*2.125
20*2.125/2.35



XW-TR-11

12*2.125
14*2.125
16*2.125
18*2.125
20*2.125/1.95
24*1.95/2.125
22*1.95
26*1.95/2.125



XW-TR-12

28*1 1/2



XW-TR-13

20*1.75
22*1.75
24*1.75
26*1.75



XW-TR-14

12*1.75
14*1.75
16*1.75
18*1.75



XW-TR-15

24*1 3/8
26*1 3/8



XW-TR-16

12*2.125
14*2.125
16*2.125
18*2.125
20*2.125



XW-TR-17

26*2.125
26*2*1 3/4



XW-TR-18

26*1 1/2*15/8



XW-TR-19

16*3.0
20*3.0
24*3.0
26*3.0



XW-TR-20

20*2.125



XW-TR-21

20*2.125
24*1.95
26*1.95



XW-TR-22

2.75-17 TL
2.25-17



XW-TR-23

3.00-17
3.00-18



XW-TR-24

3.00-18



XW-TR-25

2.75-17 TL
2.75-14
2.50-14
2.25-14



XW-TR-26

2.50-17



XW-TR-27

3.25-16



XW-TR-28

SIZE: 12/16/20



XW-TR-29

SIZE: 12/16/20



XW-TR-30

SIZE: 12/16/20



XW-TB-01

NR



XW-TB-02

BR



XW-TB-03



XW-VV-1 ITEM: 英式 E.V



XW-VV-2 ITEM: 德式 D.V



XW-VV-3 ITEM: 法式 E.V



XW-VV-4 ITEM: 美式 A.V



XW-QX-01



XW-QX-02



XW-QX-03

STEEL
Number:1PCS
GW,NW: 11/10KGS
Meas:103*77*12CM



XW-QX-04

Number:1PCS
GW,NW: 7/8KGS
Meas:87*21*13CM



XW-QX-05

Number:1PCS
GW,NW: 7/8KGS
Meas:108*17*16CM



XW-QX-06

Number:1PCS
GW,NW: 7/8KGS
Meas:87*21*13CM



XW-QX-07

Number:2PCS
GW,NW: 15/16KGS
Meas: 58*34*46CM



XW-QX-08

Number:2PCS
GW,NW: 15/16KGS
Meas: 58*34*46CM



XW-QX-09

Number:2PCS
GW,NW: 14/15KGS
Meas: 80*25*25CM



XW-QX-10

Number:2PCS
GW,NW: 14/15KGS
Meas: 80*25*25CM





XW-QX-22



XW-QX-23



XW-QX-24



XW-QX-25



XW-QX-26



XW-QX-27



XW-QX-28



XW-QX-29

Material: STEEL

Number: 10PCS

GW.NW: 20.5 / 19.5KGS

Meas: 74x47x22CM



XW-QX-30

Material: STEEL

Number: 10PCS

GW.NW: 20.5 / 19.5KGS

Meas: 74x47x22CM





XW-810H

BICYCLE TOOL SET 38PCS	
38件套自行车修理套组	
CHAIN RIVET EXTRACTOR	1PC
拆链器	
COLD PATCH REPAIR KIT	1SET
补胎套装	
20 IN FOLDING TOOL	1PC
二十合一折叠工具	
CHAIN CHECKER	1PC
链条尺	
FREEWHEEL REMOVER+WRENCH	1PC
卡飞套筒+扳手	
FORGED O SPOKE ADJUSTER 10/11/12/13/14/15G	1PC
辐条工具10/11/12/13/14/15G	
TIRE LEVER	3PC
撬胎棒	
HUB CONE SPANNER 13/14/15/16MM	2PC
花鼓扳手13/14/15/16MM	
COTTERLESS CRANK TOOL	1PC
牙盘拆卸拉马	
Y WRENCH 8/9/10MM	1PC
Y型扳手8/9/10MM	
CARTRIDGE B.B. TOOL+WRENCH	1PC
中轴套筒+扳手	
COTTERLESS CRANK WRENCH 9/10MM	1PC
牙盘钉扳手9/10MM	
FREEWHEEL WRENCH + HUB CONE WRENCH	1PC
三合一脚踏扳手	
B.B. CUP TOOLS AND COTTERLESS CRANK WRENCH 1SET	
一体中轴扳手+曲柄工具	



XW-810LC1

BICYCLE TOOL SET 13PCS	
13件套自行车修理套组	
CARTRIDGE B.B.TOOL	1PC
中轴套筒	
TIRE LEVER	2PCS
撬胎棒	
COTTERLESS CRANK TOOL	1PC
牙盘拆卸拉马	
FREEWHEEL REMOVER	1PC
卡飞套筒	
COTTERLESS CRANK WRENCH 9/10MM	1PC
牙盘钉扳手9/10MM	
CHAIN RIVET EXTRACTOR	1PC
拆链器	
FORGED O SPOKE ADJUSTER 3.2/3.3/3.5MM	1PC
辐条工具3.2/3.3/3.5MM	
8MM L HANDLE + SQUARE NUT	1SET
8MM内六角扳手+四方帽	
FREEWHEEL WRENCH 1PC	1PC
飞轮扳手	
CRANK INSTALLATION TOOL	1PC
曲柄盖拆卸工具	
B.B. WRENCH.	1PC
一体中轴扳手	



XW-810G

BICYCLE TOOL SET 38PCS	
38件套自行车修理套组	
CHAIN RIVET EXTRACTOR	1PC
拆链器	
COLD PATCH REPAIR KIT	1SET
补胎套装	
20 IN FOLDING TOOL	1PC
二十合一折叠工具	
CHAIN CHECKER	1PC
链条尺	
FREEWHEEL REMOVER	1PC
卡飞套筒	
FORGED O SPOKE ADJUSTER 11/12/13/14/15G	1PC
辐条工具11/12/13/14/15G	
TIRE LEVER	3PC
撬胎棒	
HUB CONE SPANNER 13/14/15/16MM	2PC
花鼓扳手13/14/15/16MM	
COTTERLESS CRANK TOOL	1PC
牙盘拆卸拉马	
Y WRENCH 8/9/10MM	1PC
Y型扳手	
CARTRIDGE B.B. TOOL	1PC
中轴套筒	
COTTERLESS CRANK WRENCH 9/10MM	1PC
牙盘钉扳手9/10MM	
FREEWHEEL WRENCH+HUB WRENCH	1PC
三合一脚踏扳手	
B.B. CUP TOOLS AND COTTERLESS CRANK WRENCH 1SET	
一体中轴扳手+曲柄工具	
8MM L HANDLE+SQUARE NUT	1SET
8MM内六角扳手+四方帽	



TOOL KIT
自行车补胎套组
15 IN FOLDING BICYCLE TOOL SET 1SET
十五合一折叠工具 2PC
TIRE LEVER
撬胎棒
COLD PATCH REPAIR KIT 1SET
补胎套装

XW-8090



TOOL KIT
自行车补胎套组
15 IN FOLDING BICYCLE TOOL SET 1SET
十五合一折叠工具 2PC
TIRE LEVER
撬胎棒
COLD PATCH REPAIR KIT 1SET
补胎套装

XW-8090AB



19 IN FOLDING BICYCLE TOOL SET
19合一折叠工具
SIZE7-HEX:2/2.5/3/4/5/6/8MM
内六角扳手: 2/2.5/3/4/5/6/8MM
2-SCREW DRIVER: +/-
十字/-字螺丝刀
3-RING WRENCH: 8/10/15MM
梅花扳手
3-SPOKE WRENCH: 12/14/15G
辐条扳手 12/14/15G
2-TIRE LEVER
撬胎棒
1-CHAIN HOOK
链条勾
1-CHAIN RIVET EXTRACTOR
拆链器

XW-820A



TIRE REPAIR KIT
自行车补胎套组
TIRE LEVER 2PC
撬胎棒
10 IN FOLDING BICYCLE TOOL SET 1SET
15合一折叠工具
COLD PATCH REPAIR KIT 1SET
补胎套装
4-WAY SPANNER 1PC
四孔扳手

XW-720E5



TIRE REPAIR KIT
补胎套装 2PC
TIRE LEVER
撬胎棒
COLD PATCH REPAIR KIT 1SET
补胎套组

XW-720E



15 IN FOLDING BICYCLE TOOL SET
十五合一折叠工具
SIZE:6 HEX:2/3/4/5/6/8MM
内六角扳手: 2/3/4/5/6/8MM
3-SCREWDRIVER: +/-/*
十字/-字/梅花螺丝刀
2-TIRE LEVER
撬胎棒
1-CHAIN RIVET EXTRACTOR
拆链器
2-SPOKE WRENCH: 14/15G
辐条扳手: 14/15G
1-CHAIN HOOK
链条勾

XW-804C



13 IN FOLDING BICYCLE TOOL SET
十三合一折叠工具
SIZE:6 HEX:2/2.5/3/4/5/6MM
内六角扳手: 2/2.5/3/4/5/6MM
2-SCREWDRIVER: +/-
十字/-字螺丝刀
1-TIRE LEVER
撬胎棒
1-SPOKE WRENCH: 14G
辐条扳手 14G
3-SOCKET: 8/9/10MM
套筒: 8/9/10MM

XW-801



12 IN FOLDING BICYCLE TOOL SET
12合一折叠工具
SIZE7-HEX:2/2.5/3/4/5/6/8MM
内六角扳手: 2/2.5/3/4/5/6/8MM
3-SCREW DRIVER: +/-/*
十字/-字/梅花螺丝刀
1-CHAIN RIVET EXTRACTOR
拆链器
1-TIRE LEVER
撬胎棒

XW-835S



18 IN FOLDING BICYCLE TOOL SET
18合一折叠工具
SIZE7-HEX:2/2.5/3/4/5/6/8MM
内六角扳手: 2/2.5/3/4/5/6/8MM
2-SCREWDRIVER: +/-
十字/-字螺丝刀
5-RING WRENCH: 8/9/10/13/15MM
梅花扳手 8/9/10/13/15MM
3-SPOKE WRENCH: 0.136" /14/15G
辐条扳手: 0.136" /14/15G
1-CHAIN RIVET EXTRACTOR
拆链器

XW-820D



8 IN FOLDING BICYCLE TOOL SET
八合一折叠工具
SIZE:6-HEX:2/2.5/3/4/5/6MM
2-SCREWDRIVER: +/-
十字/-字螺丝刀

XW-804A



XW-706A
CARTRIDGE B.B TOOL
中轴套筒



XW-706B
CARTRIDGE B.B TOOL
中轴套筒



XW-706C
CARTRIDGE B.B TOOL
中轴套筒



XW-706D
CARTRIDGE B.B TOOL
FOR ISIS AXLE
中轴套筒



XW-712
FREEWHEEL REMOVER
Φ22.5mm
飞轮工具



XW-714
FREEWHEEL REMOVER
Φ24.5mm
飞轮工具



XW-713
8-NOICH CARTRIDGE B.B AND
CHAINWHEEL TOOL
飞轮工具



XW-715B
FREEWHEEL REMOVER
Φ23mm
飞轮工具



XW-712A
FREEWHEEL REMOVER
Φ22.5mm
飞轮套筒



XW-724
CHAIN RIVET EXTRACTOR
拆链器



XW-724G
BIG CHAIN RIVET EXTRACTOR
FOR MOTORCYCLE
摩托车拆链器



XW-725
COTTERLESS CRANK TOOL
曲柄工具



XW-726A
FORGED "0" SPOKE ADJUSTER
10/11/12/13/14/15G
辐条工具10/11/12/13/14/15G



XW-6252
COMBINATION SPANNER SET
SIZE: 8/10/12/13/14/15/17/19/22/24MM
组合扳手: 8/10/12/13/14/15/17/19/22/24MM



XW-734
"Y" BOX WRENCH
SIZE: 8/9/10mm
"Y"型套筒扳手: 8/9/10mm



XW-700F
10-WAY SPANNER
十孔扳手



XW-726GA
14-15G SPOKE ADJUSTER
辐条工具14/15G



XW-726GB
11-12G SPOKE ADJUSTER
辐条工具11/12G



XW-726G
7-9G SPOKE ADJUSTER
辐条工具7/9G





XW-BAG-01



XW-BAG-02



XW-BAG-03



XW-BAG-04



XW-BAG-05



XW-BAG-06



XW-BAG-07



XW-BAG-08



XW-PAD-01



XW-PAD-02



XW-PAD-03



XW-PAD-04



XW-PAD-05



XW-PAD-06



XW-PAD-07



XW-PAD-08





XW-809-A

Packing size: 72*71*50 cm
Quantity: 6 1 piece



XW-809-B

Packing size: 72*71*50 cm
Quantity: 6 1 piece



XW-806

Packing size: 71*61*55 cm
Quantity: 5 1 piece



XW-805

Packing size: 71*61*55 cm
Quantity: 5 1 piece



XW-802

Packing size: 76*47*54 cm
Quantity: 5 1 piece



XW-919

MUSIC
Packing size:
82*59*45 cm
Quantity: 5 1 piece



XW-816

Butterfly disc/music disc
light wheel/ordinary wheel
Packing size:
77 * 57.5 * 42 cm
Quantity: 6 set
Color: orange powder,
blue green



XW-218

Music/light/built-in
drawstring/subwoofer
Packing size:
82*59*39cm
Quantity: 4 set
Color: Blue powder



XW-268

Packing size:
79*56*42cm
Quantity: 5 1 piece



XW-288

The beetles
Packing size:
82*59*45cm
Quantity: 5 1 piece



XW-818

Little bear
Packing size:
83*61*50cm
Quantity: 5 1 piece



XW-288-1

Packing size:
82*59*45cm
Quantity: 5 1 piece



XW-988

Packing size:
83*61*50cm
Quantity: 5 1 piece



XW-888

Packing size:
106*57*31cm
Quantity: 1 set
Color: Red white blue



XW-688

Packing size:
116*83*43cm
Quantity: 1 set



XW-666

Packing size:
118*85.5*46.5cm
Quantity: 1 set
Color: Red white
yellow blue



XW-6688
Packing size: 120*70*50cm
Quantity: 1 set



XW-1188
These horsemen
Packing size:
116*83*43cm
Quantity: 1 set



XW-518
These horsemen
Packing size:
84,5*41*46,5cm
Quantity: 1 set
COLOR: Red white blue



XW-8866
These horsemen
Packing size:
84,5*41*47cm
Quantity: 1 set



XW-9966
These horsemen
Packing size:
79*47*55cm
Quantity: 1 set



XW-6699
These horsemen
Packing size:
83*41*47cm
Quantity: 1 set



XINWANG CYCLE
CYCLE ALL OVER THE WORLD



BICYCLE SPARE PARTS

XINWANG CYCLE

XINGTAI XINWANG TRADE & AGENT CO., LTD

Tianjin factory: No.5, Chunqiu Industrial Zone, Yangliuqing, Tianjin, China.

Hebei factory: No.689, Situan Industrial Zone, Quzhou, Hebei, China.

Sales office: No.236, Xinhuanan Road, Xingtai, Hebei, China.

☎ 1292373531

🌐 w.bicycle

📞 +86 18931946189

👤 Tronest Wong

📞 +86 319 5117999

📞 +86 319 3169189

✉ xinwangbicycle@126.com

🌐 www.xinwangbicycle.com

www.xinwangbicycle.com

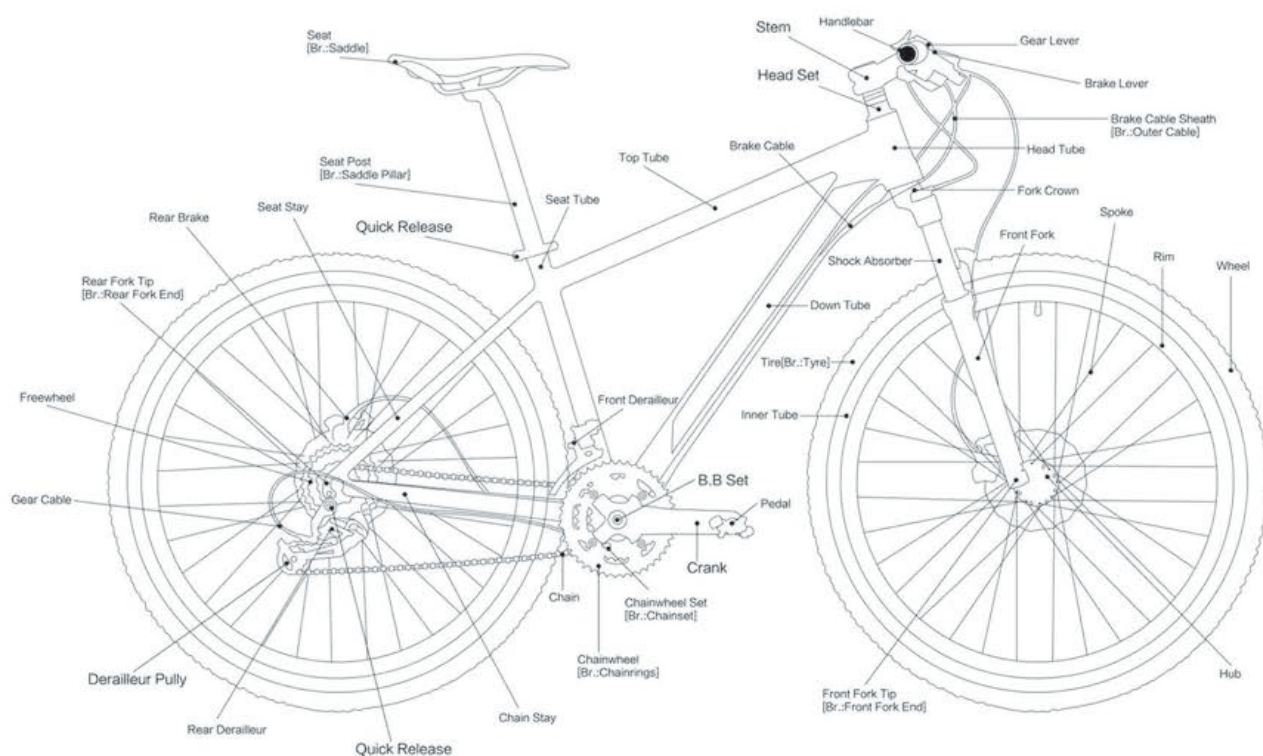

COMPANY PROFILE

XINWANG CYCLE founded in 2002 in Hebei, China, has acquired nearly 20 years of experience in the cycling field. We specialize in producing and exporting all kinds of bicycle spare parts, children bike, MTB bike, freestyle bike, city bike, lady bike etc. We will always strive to meet the commitments of all the customers and provide competitive and high-value products.

XINWANG CYCLE, cycle all over the world.